



**CALL NO. 331**

**CONTRACT ID. 182402**

**WHITLEY COUNTY**

**FED/STATE PROJECT NUMBER FD05 118 0092 004-010**

**DESCRIPTION CORN BREAD BRANCH TO BON ROAD (KY 92)**

**WORK TYPE PAVEMENT (WITH ALTERNATES)**

**PRIMARY COMPLETION DATE 9/30/2019**

**LETTING DATE: December 07,2018**

Sealed Bids will be received electronically through the Bid Express bidding service until 10:00 AM EASTERN STANDARD TIME December 07,2018. Bids will be publicly announced at 10:00 AM EASTERN STANDARD TIME.

**NO PLANS ASSOCIATED WITH THIS PROJECT.**

**REQUIRED BID PROPOSAL GUARANTY:** Not less than 5% of the total bid.

## TABLE OF CONTENTS

PART I	SCOPE OF WORK
	<ul style="list-style-type: none"><li>• PROJECT(S), COMPLETION DATE(S), &amp; LIQUIDATED DAMAGES</li><li>• CONTRACT NOTES</li><li>• STATE CONTRACT NOTES</li><li>• SURFACING AREAS</li><li>• ASPHALT MIXTURE</li><li>• INCIDENTAL SURFACING</li><li>• COMPACTION OPTION B</li><li>• SPECIAL NOTE(S) APPLICABLE TO PROJECT</li><li>• ASPHALT MIX PAVEMENT WEDGE MONOLITHIC OPERATION</li><li>• EDGE KEY (BY TON)</li><li>• ASPHALT MILLING AND TEXTURING</li><li>• TYPICAL SECTION DIMENSIONS</li><li>• TRAFFIC CONTROL PLAN 2 LANE</li><li>• DURABLE PAVEMENT EDGE DETAILS</li><li>• SKETCH MAP(S)</li><li>• SUMMARY SHEET(S)</li><li>• TYPICAL SECTION(S)</li></ul>
PART II	SPECIFICATIONS AND STANDARD DRAWINGS
	<ul style="list-style-type: none"><li>• SPECIFICATIONS REFERENCE</li><li>• SUPPLEMENTAL SPECIFICATION</li><li>• 2016 STANDARD DRAWINGS THAT APPLY</li></ul>
PART III	EMPLOYMENT, WAGE AND RECORD REQUIREMENTS
	<ul style="list-style-type: none"><li>• LABOR AND WAGE REQUIREMENTS</li><li>• EXECUTIVE BRANCH CODE OF ETHICS</li><li>• KENTUCKY EQUAL EMPLOYMENT OPPORTUNITY ACT OF 1978 LOCALITY / STATE</li><li>• PROJECT WAGE RATES / STATE</li></ul>
PART IV	INSURANCE
PART V	BID ITEMS

**PART I**  
**SCOPE OF WORK**

## ADMINISTRATIVE DISTRICT - 11

**CONTRACT ID - 182402**

**FD05 118 0092 004-010**

**COUNTY - WHITLEY**

**PCN - MP11800921803**

**FD05 118 0092 004-010**

CORN BREAD BRANCH TO BON ROAD (KY 92) (MP 4.000) BEGIN 290 FEET EAST OF OLD JELICO ROAD  
EXTENDING EAST TO 522 FEET EAST OF KY 296 (MP 9.550), A DISTANCE OF 05.55 MILES.PAVEMENT (WITH  
ALTERNATES)

GEOGRAPHIC COORDINATES LATITUDE 36:42:12.79 LONGITUDE 84:11:57.53

**COMPLETION DATE(S):**

COMPLETED BY 09/30/2019

APPLIES TO ENTIRE PROJECT

## **CONTRACT NOTES**

### **PROPOSAL ADDENDA**

All addenda to this proposal must be applied when calculating bid and certified in the bid packet submitted to the Kentucky Department of Highways. Failure to use the correct and most recent addenda may result in the bid being rejected.

### **BID SUBMITTAL**

Bidder must use the Department's electronic bidding software. The Bidder must download the bid file located on the Bid Express website ([www.bidx.com](http://www.bidx.com)) to prepare a bid packet for submission to the Department. The bidder must submit electronically using Bid Express.

### **JOINT VENTURE BIDDING**

Joint venture bidding is permissible. All companies in the joint venture must be prequalified in one of the work types in the Qualifications for Bidders for the project. The bidders must get a vendor ID for the joint venture from the Division of Construction Procurement and register the joint venture as a bidder on the project. Also, the joint venture must obtain a digital ID from Bid Express to submit a bid. A joint bid bond of 5% may be submitted for both companies or each company may submit a separate bond of 5%.

### **UNDERGROUND FACILITY DAMAGE PROTECTION**

The contractor shall make every effort to protect underground facilities from damage as prescribed in the Underground Facility Damage Protection Act of 1994, Kentucky Revised Statute KRS 367.4901 to 367.4917. It is the contractor's responsibility to determine and take steps necessary to be in compliance with federal and state damage prevention directives. When prescribed in said directives, the contractor shall submit Excavation Locate Requests to the Kentucky Contact Center (KY811) via web ticket entry. The submission of this request does not relieve the contractor from the responsibility of contacting non-member facility owners, whom shall be contacted through their individual Protection Notification Center. Non-compliance with these directives can result in the enforcement of penalties.

### **REGISTRATION WITH THE SECRETARY OF STATE BY A FOREIGN ENTITY**

Pursuant to KRS 176.085(1)(b), an agency, department, office, or political subdivision of the Commonwealth of Kentucky shall not award a state contract to a person that is a foreign entity required by [KRS 14A.9-010](#) to obtain a certificate of authority to transact business in the Commonwealth ("certificate") from the Secretary of State under [KRS 14A.9-030](#) unless the person produces the certificate within fourteen (14) days of the bid or proposal opening. If the foreign entity is not required to obtain a certificate as provided in [KRS 14A.9-010](#), the foreign entity should identify the applicable exception. Foreign entity is defined within [KRS 14A.1-070](#).

**For all foreign entities required to obtain a certificate of authority to transact business in the Commonwealth, if a copy of the certificate is not received by the contracting agency within the time frame identified above, the foreign entity's solicitation response shall be deemed non-responsive or the awarded contract shall be cancelled.**

Businesses can register with the Secretary of State at <https://secure.kentucky.gov/sos/ftbr/welcome.aspx>.

### **SPECIAL NOTE FOR PROJECT QUESTIONS DURING ADVERTISEMENT**

Questions about projects during the advertisement should be submitted in writing to the Division of Construction Procurement. This may be done by fax (502) 564-7299 or email to [kytc.projectquestions@ky.gov](mailto:kytc.projectquestions@ky.gov). The Department will attempt to answer all submitted questions. The Department reserves the right not to answer if the question is not pertinent or does not aid in clarifying the project intent.

The deadline for posting answers will be 3:00 pm Eastern Daylight Time, the day preceding the Letting. Questions may be submitted until this deadline with the understanding that the later a question is submitted, the less likely an answer will be able to be provided.

The questions and answers will be posted for each Letting under the heading "Questions & Answers" on the Construction Procurement website ([www.transportation.ky.gov/contract](http://www.transportation.ky.gov/contract)). The answers provided shall be considered part of this Special Note and, in case of a discrepancy, will govern over all other bidding documents.

### **HARDWOOD REMOVAL RESTRICTIONS**

The US Department of Agriculture has imposed a quarantine in Kentucky and several surrounding states, to prevent the spread of an invasive insect, the emerald ash borer. Hardwood cut in conjunction with the project may not be removed from the state. Chipping or burning on site is the preferred method of disposal.

### **INSTRUCTIONS FOR EXCESS MATERIAL SITES AND BORROW SITES**

Identification of excess material sites and borrow sites shall be the responsibility of the Contractor. The Contractor shall be responsible for compliance with all applicable state and federal laws and may wish to consult with the US Fish and Wildlife Service to seek protection under Section 10 of the Endangered Species Act for these activities.

### **ACCESS TO RECORDS**

The contractor, as defined in KRS 45A.030 (9) agrees that the contracting agency, the Finance and Administration Cabinet, the Auditor of Public Accounts, and the Legislative Research Commission, or their duly authorized representatives, shall have access to any books, documents, papers, records, or other evidence, which are directly pertinent to this contract for the purpose of financial audit or program review. Records and other prequalification information confidentially

disclosed as part of the bid process shall not be deemed as directly pertinent to the contract and shall be exempt from disclosure as provided in KRS 61.878(1)(c). The contractor also recognizes that any books, documents, papers, records, or other evidence, received during a financial audit or program review shall be subject to the Kentucky Open Records Act, KRS 61.870 to 61.884.

In the event of a dispute between the contractor and the contracting agency, Attorney General, or the Auditor of Public Accounts over documents that are eligible for production and review, the Finance and Administration Cabinet shall review the dispute and issue a determination, in accordance with Secretary's Order 11-004.

April 30, 2018

## **SPECIAL NOTE FOR RECIPROCAL PREFERENCE**

### **RECIPROCAL PREFERENCE TO BE GIVEN BY PUBLIC AGENCIES TO RESIDENT BIDDERS**

By reference, KRS 45A.490 to 45A.494 are incorporated herein and in compliance regarding the bidders residency. Bidders who want to claim resident bidder status should complete the Affidavit for Claiming Resident Bidder Status along with their bid in the electronic bidding software. Submittal of the Affidavit should be done along the bid in Bid Express.

April 30, 2018



### **SURFACING AREAS**

The Department estimates the mainline surfacing width to be varied 21 to 50.5 feet.

The Department estimates the total mainline area to be surfaced to be 115,479 square yards.

The Department estimates the shoulder width to be 1.5 feet on each side.

The Department estimates the total shoulder area to be surfaced to be 195 square yards.

### **ASPHALT MIXTURE**

Unless otherwise noted, the Department estimates the rate of application for all asphalt mixtures to be 110 lbs/sy per inch of depth.

### **INCIDENTAL SURFACING**

The Department has included in the quantities of asphalt mixtures established in the proposal estimated quantities required for resurfacing or surfacing mailbox turnouts, farm field entrances, residential and commercial entrances, curve widening, ramp gores and tapers, and road and street approaches, as applicable. Pave these areas to the limits as shown on Standard Drawing RPM-110-06 or as directed by the Engineer. In the event signal detectors are present in the intersecting streets or roads, pave the crossroads to the right of way limit or back of the signal detector, whichever is the farthest back of the mainline. Surface or resurface these areas as directed by the Engineer. The Department will not measure placing and compacting for separate payment but shall be incidental to the Contract unit price for the asphalt mixtures.

### **OPTION B**

Be advised that the Department will control and accept compaction of asphalt mixtures furnished on this project under OPTION B in accordance with Sections 402 and 403.

## SPECIAL NOTE FOR THERMOPLASTIC PAVEMENT MARKINGS REMOVAL

---

Remove existing Thermoplastic Pavement Markings just prior to placement of the Scrub Seal as directed by the Engineer. The Department will not measure removal of the Thermoplastic Pavement Markings, but shall be incidental to the Thermoplastic Stop Bars.

## SPECIAL NOTE FOR MICROSURFACING

**1. DESCRIPTION.** This work consists of constructing a cold-laid, polymer-modified, emulsified asphalt pavement course to fill ruts or provide an intermediate or surface course for existing pavements. The paving mixture is composed of a polymer-modified emulsified asphalt, crushed aggregate, mineral filler, water, and possibly other additives. Follow the requirements outlined in ASTM D 6372, Standard Practice for Design, Testing, and Construction of microsurfacing, with modifications as found in this note. Apply this material according to the lines, grades, and typical cross-sections in the plans or as established by the Engineer.

Unless otherwise noted, Section references herein are to the Department's Standard Specifications for Road and Bridge Construction, current edition. All applicable portions of the Department's Standard Specifications apply unless specifically modified herein.

### 2. MATERIALS AND EQUIPMENT.

**2.1 Mineral Filler.** Use Portland Cement, Type I, conforming to Section 801.

**2.2 Aggregate.** Provide 100-percent crushed aggregate conforming to Sections 804 and 805. Contrary to Subsection 403.03.03, provide polish-resistant aggregate in the asphalt mixture conforming to one of the following requirements:

#### **Microsurfacing Type A**

- 100 percent of total combined aggregate is Class A polish-resistant aggregate.

- 

#### **Microsurfacing Type B**

- 100 percent of total combined aggregate is Class B or Class A polish-resistant aggregate.

- 

#### **Microsurfacing Type D**

- No polish-resistant aggregate requirements.

Contrary to ASTM D 6372, test sand equivalent according to AASHTO T 176, soundness according to Kentucky Method (KM) 64-610, and a maximum LA abrasion resistance of

35 percent when tested according to AASHTO T 96. Ensure all aggregates satisfy ASTM D 6372 for sand equivalent, soundness, and LA abrasion listed above.

Do not use mineral aggregates that are inherently porous, such as blast-furnace slag, expanded shale, porous limestone, and lightweight aggregates, in this mixture.

**2.3 Water.** Conform to Section 803.

**2.4 Emulsified Asphalt.** The polymer-modified emulsion will be a CQS-1hP conforming to AASHTO M 316 and tested according to T59. Distill sample at 350 °F. In addition, ensure that the emulsified asphalt conforms to the following criteria:

<u>Test</u>	<u>Criteria</u>
Ductility at 77 °F (AASHTO T 51)	40 cm (min)

Ensure the asphalt supplied can be found on the List of Approved Materials.

**2.5 Equipment.** All equipment necessary for the satisfactory performance of the work shall be on hand and approved before the work is permitted to begin. All equipment, tools, and machines used in the performance of this work shall be maintained in satisfactory working condition.

All trucks shall be covered immediately after loading with a cover of canvas or other suitable material. The cover shall lap down along the sides and rear of the truck bed a minimum of 6 in. and be secured by tie downs at a maximum of 5 ft. spacing along the sides and rear of the truck bed. All trucks must be equipped to meet the above requirements prior to commencing hauling operations.

**2.6 Mixing Equipment.** Produce the mixture in a self-propelled, front-feed, continuous-loading machine equipped with a conveyer-belt aggregate-delivery system and an interconnected, positive-displacement, water-jacketed gear pump and/or a variable displacement computerized rate control pump, to accurately proportion the aggregate and asphalt emulsion. Locate the mineral filler feed so the proper amount of mineral filler is dropped on the aggregate before discharge into the pug mill. Provide a spray bar to completely pre-wet the aggregate dropping down to the pug mill with additive and water before the introduction of the asphalt emulsion. Provide a twin-shaft, continuous-flow, multi-blade pug mill that is a minimum of 49 in. long. Ensure that the blade size and side clearances meet the equipment manufacturer's recommendations. Introduce the emulsion within the first one-third of the mixer length to ensure proper mixing of all materials before exiting the pug mill.

Equip the machine with opposite-side driving stations to allow full control of the machine from either side. Equip the mixer with a remote, forward-speed control at the rear mixing

platform so the rear operator can control the forward speed and level of mixture in the paving or rut box. Provide material control devices that are readily accessible and positioned so the amount of each material used can be determined at any time.

Equip the mixing machine with a water pressure system and nozzle-type spray bar to provide a water spray ahead of and outside the spreader box when required. Apply water at a rate that will dampen the surface but not create free-flowing water ahead of the spreader box.

The mixer shall be equipped with a computerized material monitoring system with integrated material control devices that are readily accessible and positioned so the amount of each material used can be determined at any time. The mixer shall be equipped with a back-up electronic materials counter that is capable of recording running count totals for each material being monitored. The mixer shall include an attached radar ground measuring device or comparable device. Each material control device shall be calibrated prior to each mix application and at the discretion of the Engineer. The computer system shall have the capability to record, display, and print the following information:

- Individual sensor counts for emulsion, aggregate, cement, water and additive
- Aggregate, emulsion, and cement output in pounds per minute
- Ground travel distance
- Spread rate in pounds per square yard
- Percentages of emulsion, cement, water and additive
- Cumulative totals of aggregate, emulsion, cement, water and additive
- Scale factor for all materials

The computer system shall be functional at the beginning of work, and throughout the entire work operation.

**2.7 Aggregate Equipment.** In an effort to eliminate oversize materials in the finished mat, aggregate shall be screened directly into the trucks. The inspector shall view the screen for oversized aggregate and if it is found to have gaps, it shall be replaced or repaired before continuing to place the material.

**2.8 Spreading Equipment.** If a leveling or surface course is specified, apply the mixture uniformly by means of a conventional spreader box.

If a rut-fill course is specified, apply the mixture with a 5-6ft width, "V-shaped" rut-filling spreader box. Equip the rut-filling spreader box with a steel strike-off device.

Attach either type of spreader box to the mixer, and equip it with augers mounted on an adjustable shaft to continually agitate and distribute the materials throughout the box. Ensure that the equipment provides sufficient turbulence to prevent the mix from setting in the box or causing excessive build-up or lumps. To prevent loss of the mixture from the box, attach flexible seals, front and rear, in contact with the road. Operate the

spreading equipment in such a manner as to prevent the loss of the mixture on super-elevated curves.

For surface courses, attach a secondary strike-off device to the spreader. Use neoprene rubber drags to obtain the desired finish. Replace drags having excessive buildup. Do NOT use burlap drags.

**2.9 Calibration Equipment.** Supply all of the equipment, materials, and certified scales necessary to perform the calibration according to Section 3.5 of this note.

### **3. CONSTRUCTION.**

**3.1 Preparation and Proportioning of Mixture.** Submit a complete mix design to the Division of Construction and to the Division of Materials, Asphalt Branch and Aggregate Section. Mix design shall be prepared by an approved laboratory, to verify the compatibility of the aggregate, asphalt emulsion, mineral filler, and other additives. Perform the mix design with the same materials that will be used on the project.

Ensure the mix design has a residual asphalt content, by dry weight of aggregate, of 7.0 to 8.5 percent for leveling and surface courses and 6.5 to 8.0 percent for rut-filling mixes. Also ensure the mixture contains no reclaimed materials and a mineral filler content between 0.25 and 2.0 percent by dry weight of aggregate.

In addition to the mix design information required by KM 64-421, provide the following (all percentages are based on the dry weight of aggregate):

- minimum and maximum percentage of water; and
- percentage of mix-set additives, if required.
- county and contract listed

Provide test results from an accredited laboratory that conform to ASTM D 6372.

Submit the mix design and two full 5-gallon buckets of the aggregate blend for the mixture to the Division of Materials for verification according to Subsection 402.03 a minimum of four weeks prior to initial use for testing and approval.

When requested by the Engineer, the Contractor shall calculate the % asphalt content of the mixture from the equipment computer display readings. If no request is made by the Engineer, the Contractor shall calculate the % asphalt content of the mixture from the equipment computer display readings randomly, a minimum of 3 times a day. The quality control tolerances from the mix design is  $\pm 0.5\%$ .

**3.2 Mixture Gradation.** Conform to the Type II requirements that are listed in Table 1 for surface courses and leveling when used as a leveling course and Type III requirements that are listed in Table 2 for leveling when used as a surface course in a double microsurfacing application and rut-fill courses.

**3.3 Weather Limitations.** In addition to the applicable requirements in ASTM D 6372, apply the mixture only when rain is not imminent and the existing pavement surface temperature is at least 50 °F. The ambient temperature shall be at least 50• F and rising and no forecasted temperatures shall be below 32 °F within a 24 hour period after placement. Do not place the material between November 1 and May 1.

**3.4 Surface Preparation.** All surfaces intended for application shall be thoroughly cleaned of all vegetation, loose material, dirt, or other objectionable material immediately before application of emulsion using a mechanical sweeper and wire hand brooms.

Remove pavement markers at least 24 hours in advance of paving operation and fill the areas with microsurface material, asphalt material, or other approved material meeting the engineer's specifications. Remove any loose crack sealing material in advance of paving operation.

Remove existing thermoplastic and/or excessive paint markings prior to application.

Contrary to Section 406, apply an approved tack coat material diluted to 2 to 1 at rate of 0.03 to 0.06 gal/yd<sup>2</sup>. Application rate shall be adjusted based on the surface texture and/or porosity. Do not apply tack coat on top of a rut fill or leveling course prior to placing surface course. For a double microsurface treatment, do not apply a tack coat between the first and second application. Apply tack coat only to surfaces that will be covered by the application in the same day. The tack coat material shall be a polymer-modified emulsion CQS-1HP or CSS-1H emulsion.

**3.5 Calibration.** Before mix production, calibrate the mixing equipment in the presence of the Engineer. Generate documentation for the Engineer, including individual calibrations of each material at various settings. Perform a new calibration if there is any change in the mix design. Following calibration and adjustments for changes in the mix design, do not make any further calibration adjustments to the mixing equipment without the Engineer's approval.

**3.6 Application.** Apply the paving mixture in a manner to fill minor surface irregularities and achieve a uniform surface without causing streaking, drag marks, skips, lumps, or tears. Carry a sufficient amount of material in the spreader box at all times to ensure complete and uniform coverage. Avoid overloading the spreader box. Do not allow lumping, balling, or unmixed aggregate in the spreader box.

If a rut-fill course is specified, apply enough material to fill the wheel paths without excess crowning (overfilling). An excess crown is defined as 1/8 in. after 24 h of traffic compaction. Apply rut-fill courses in widths from 5 to 6 ft for each wheel path. If rut depth exceeds 1.0 inches, apply rut fill course in multiple layers. Provide a smooth, neat seam where two rut-fill passes meet. Restore the design profile of the pavement cross-section. Feather the edges of the rut-fill course to minimize the use of excess material.

Rut fill course shall not exhibit drag marks or tears greater than 1 inch wide, ½ inch in depth and greater than 12 inches in length. Rut fill course shall not exhibit excessive flushing or excessive roughness.

If a leveling course is specified, ensure the material covers the entire surface area. The leveling course may exhibit minor raveling upon opening to traffic but shall not exhibit any continued raveling after the first four hours to traffic. Leveling course shall not exhibit drag marks or tears greater than ½ inch wide, ¼ inch in depth and greater than 12 inches in length. Leveling course shall not exhibit flushing or excessive roughness.

If a leveling course is specified for a double layer of microsurfacing, utilize a type III aggregate and apply the paving mixture at a minimum dry aggregate rate of 18 lb/yd<sup>2</sup>. If a type II mixture is specified to be use as minor leveling, apply the paving mixture at a minimum dry aggregate rate of 14 lb/yd<sup>2</sup>. If a surface course is specified over a leveling course for a double layer, utilize a type II aggregate and apply the paving mixture at a minimum dry aggregate rate of 18 lb/yd<sup>2</sup>. If a single layer surface course is specified, utilize a type II aggregate and apply the paving mixture at a dry aggregate rate of 24 lb/yd<sup>2</sup>. For leveling course provide an even layer creating a neat center seam with no overlap where two passes meet. For surface courses, provide a smooth, neat center seam with a maximum overlap of 2 inches where two passes meet.

Construct surface courses wide enough to cover the outside edges of rut-fill and leveling courses. Maintain straight edge lines along curbs and shoulders. Do not allow runoff in these areas. Ensure that lines at the intersections are straight. Immediately remove excess material from the ends of each run.

Use squeegees and lutes to spread the mixture in areas inaccessible to the spreader box and areas requiring hand-spreading. With the Engineer's approval, adjust the mix-set additive to provide a slower setting time if hand-spreading is needed. Do not adjust the water content. If hand-spreading, pour the mixture in a small windrow along one edge of the surface to be covered, and spread it uniformly by a hand squeegee or lute. Do not over spray the mixture with water by the use of a hose or other equipment.

Ensure the material cures at a rate that will permit traffic on the pavement within one hour of placement or time specified by the engineer.

If the final surface is not uniform in texture, free from streaks, drag marks, lumps, or tears, stop applying mixture and correct the problem. Do not resume work until the engineer is satisfied the problem has been corrected. If surface correction is necessary, due to traffic, rain, or other causes during construction of the project, repair areas of the surface.

If excessive flushing or bleeding occurs within 30 to 60 days after the treatment is applied, corrective work will be required at the contractor's expense.

### **3.7 Acceptance and Verification.**

**3.7.1 Proportion and Spread Rate.** Maintain continuous control of the emulsified asphalt-to-dry aggregate proportion to conform to the approved mix design within a tolerance of  $\pm 2$  gal/ton. Ensure the spread rate satisfies the specified quantity of aggregate per square yard on a dry-weight basis.

The Contractor shall calculate the yield of the course being placed from the equipment computer display readings. If no request is made by the Engineer, the Contractor shall calculate the yield of the course being placed from the equipment computer display readings randomly, a minimum of 3 times a day and at the end of each day(s) of production.

The Department will base acceptance of the emulsified asphalt-to-dry aggregate proportion and the spread rate on the Engineer's summary of daily quantities. The Department will accept a day's application of microsurfacing provided the Engineer's summary indicates conformance with the requirements for proportion and spread rate.

**3.7.2 Emulsified Asphalt.** Submit samples of the polymer-modified emulsion to the Division of Materials for testing at a frequency of one sample per lot.

**3.7.3 Mixture Gradation.** The Department will perform combined-gradation determinations on the aggregates used in the microsurfacing at a frequency of one per day of production. When the combined-gradation fails to meet the master range for the type of aggregate, the Department will apply a reduction on the invoice price of the aggregate as listed in Table 1 and Table 2. Contrary to section 804.10 the Department will impose a reduction in payment no matter the quantities used.

**3.8 Documentation.** The Contractor shall maintain a daily report including the following information:

- Aggregate used, ton (dry)
- Microsurfacing emulsion used, ton
- Bituminous Materials for Tack Coat, ton
- Cement used, ton
- Water used in mixture, gallons
- Additive used in mixture, gallons
- Moisture Content
- Yield, dry aggregate lb/yd<sup>2</sup>
- Square yards placed
- Rate of Application

**3.9 Test Strip Construction.** Prior to production application, the Contractor shall place a test section 1,000 ft. in length and one lane wide. The test strip shall demonstrate the mix and set time of the material and the ability to perform under traffic. If handwork will be required on the project, include handwork in the test strip. The test strip shall be placed at the same general time of day as paving is to take place (night or day), and under similar ambient conditions. The test strip shall be able to carry normal traffic within 60



minutes. If normal traffic cannot be carried, the emulsion or mixture must be adjusted and another test strip will be required. Upon approval of the test strip, the Contractor can begin application. Payment will only be made for the first test strip.

**4. MEASUREMENT.** The Department will pay for surface and leveling microsurfacing courses by the number of square yards, complete and accepted in place. The Department will pay for microsurfacing rut-fill course by the number of tons of dry aggregate used, complete and accepted in place. The weight of the dry aggregate used will be based on the calibrated weight of aggregate provided by the paving machine.

The Department will base the width of the pavement course on the width shown on the plans or as directed by the Engineer. The Department will measure the length along the centerline of each roadway or ramp.

The Department will not measure the surface preparation for payment and will consider it incidental to the microsurfacing.

The Department will not measure asphalt material for tack for payment and will consider it incidental to microsurfacing

**5. PAYMENT.** The Department will consider the unit bid price per square yard to include all labor, materials, and equipment necessary to complete the work. The Department will make payment for the completed and accepted quantities according to the following:

<b>Emulsified Asphalt Price Adjustment Schedule</b>						
Test	Specification	100% Pay	90% Pay	80% Pay	50% Pay	0% Pay
CQS-1hP						
Viscosity, 77 ° F (SFS) AASHTO T 59	20 - 100	18 - 110	15 - 17 111 - 120	12 - 14 121 - 130	9 - 11 131 - 140	≤8 • 141
Residue Penetration, 77 •F AASHTO T 59	40 - 90	37 - 98	34 - 36 99 - 108	31 - 33 109 - 120	28 - 30 121 - 130	• 27 • 131
Softening Point, AASHTO T 53	• 135	• 130	127 - 134	128 - 129	126 - 127	• 125
Distillation Residue, % AASHTO T 59, 350•F	≥ 62.0	≥ 60.0	59.5	59.0	58.5	≤ 58.4
Sieve, % AASHTO T 59	• 0.1	• 0.3	0.31 – 0.45	0.46 – 0.60	0.61 – 0.75	• 0.76
Residue Elastic Recovery @ 50 ° F, % AASHTO T 301	≥ 60.0	≥ 58.0	57.0	56.0	55.0	≤ 54.9
Residue Ductility @ 77 • F, cm	• 40	• 38	37	36	35	• 34

**TABLE 1**

<b>GRADATION - MICROSURFACING TYPE II SAND</b>								
Payment	Sieve Size-Percent Passing							
Reduction	3/8	No. 4	No. 8	No. 16	No. 30	No. 50	No. 100	No. 200
0%	100	90-100	60-90	40-70	25-50	15-30	10-21	5-15
10%			58-59	38-39	23-24	13-14	8-9	4
10%	98-100	88-89	91-92	71-72	51-52	31-32	22-23	16
20%			57	37	22	12	7	3
20%	97	87	93	73	53	33	24	17
30%			56	36	21	11	6	2
30%	96	86	94	74	54	34	25	18
50%			55	35	20	10	5	1
50%	95	85	95	75	55	35	26	19

**TABLE 2**

<b>GRADATION - MICROSURFACING TYPE III SAND</b>								
Payment	Sieve Size-Percent Passing							
Reduction	3/8	No. 4	No. 8	No. 16	No. 30	No. 50	No. 100	No. 200
0%	100	70-100	45-70	28-50	19-34	12-25	7-18	5-15
10%			43-44	26-27	17-18	10-11	5-6	4
10%	98-100	68-69	71-72	51-52	35-36	26-27	19-20	16
20%			42	25	16	9	4	3
20%	97	67	73	53	37	28	21	17
30%			41	24	15	8	3	2
30%	96	66	74	54	36	29	22	18
50%			40	23	14	7	2	1
50%	95	65	75	55	35	30	23	19

If the Department determines that the minimum rate of application has not been obtained for each day of production, then the Department will reduce the bid payment as according to Tables 3, 4, and 5 listed below.

Table 3

Payment Based on Rate of Application for 18 lb/yd <sup>2</sup>	
Rate of Application of Per Day of Production (lb/sy)	Reduction of Payment (%)
18 and Greater	100
17.9 - 17.5	95
17.4 - 17.0	90
16.9 - 16.5	80
16.4 - 16.0	70
15.9 and Below	50

Table 4

Payment Based on Rate of Application for 14 lb/yd <sup>2</sup>	
Rate of Application of Per Day of Production (lb/sy)	Reduction of Payment (%)
14 and Greater	100
13.9 - 13.5	95
13.4 - 13.0	90
12.9 - 12.5	80
12.4 - 12.0	70
11.9 and Below	50

Table 5

Payment Based on Rate of Application for 24 lb/yd <sup>2</sup>	
Rate of Application of Per Day of Production (lb/sy)	Reduction of Payment (%)
24 and Greater	100
23.9 - 23.5	95
23.4 - 23.0	90
22.9 - 22.5	80
22.4 - 22.0	70
21.9 and Below	50

<u>Code</u>	<u>Pay Item</u>	<u>Pay Unit</u>
20814EC	Micro Surfacing-Surface Course	Square Yard
21652EN	Micro Surfacing-Leveling Course	Square Yard
24515EC	Micro Surfacing-Rut Fill Course	Ton

**SPECIAL NOTE FOR POLISH-RESISTANT AGGREGATE IN NO 4 THINLAY ASPHALT MIXTURES**

Contrary to Subsection 403.03.03, provide polish-resistant aggregate in the ASPH SURF NO.4 asphalt mixture conforming to one of the following requirements:

**ASPH SURF NO.4A**

- 100 percent of total combined aggregate is Class A polish-resistant aggregate.

**ASPH SURF NO.4B**

- Total combined aggregate is composed of a Class A and Class B polish-resistant aggregate; or
- Minimum of 85 percent Class B polish-resistant aggregate and maximum 15% Class D aggregate of the total combined aggregate.

Contrary to Section 409.03.03 of the *Standards and Specifications*, for a 4.75mm asphalt mixture requiring a Class A or B polish resistant aggregate, the use of recycled/reclaimed materials is prohibited. For 4.75mm asphalt mixtures requiring Class D aggregate, recycled asphalt pavement (RAP) shall not exceed 15% of effective binder content, and the use of recycled asphalt shingles (RAS) is prohibited.

### **SPECIAL NOTE FOR CRACK SEALING**

Use Crafc0 Polyfiber Type III or approved equal for the crack sealing material. Crack sealing must be completed a minimum of 30 days prior to the overlay treatment.

## SPECIAL NOTE FOR PAVEMENT WEDGE AND SHOULDER MONOLITHIC OPERATION

**1.0 MATERIALS.** Provide an Asphalt Surface Mixture conforming to Section 403 of the Standard Specifications, as applicable to the project, for the pavement wedge.

**2.0 CONSTRUCTION.** Place the specified Asphalt Surface Mixture on shoulders monolithically with the driving lane. Prime the existing shoulder with tack material as the Engineer directs before placing the wedge. Construct according to Section 403.03 of the Standard Specifications.

Equip the paver with a modified screed that extends the full width of the wedge being placed and is tapered to produce a wedge. Obtain the Engineer's approval of the modified screed before placing shoulder wedge monolithically with the driving lane.

The wedge may vary in thickness at the edge of the milled area in the shoulder. If the area to receive the shoulder wedge is milled prior to placement, during rolling operations pinch the outside edge of the new inlay wedge to match the existing shoulder elevation not being resurfaced. Unless required otherwise by the Contract, construct rolled or sawed rumble strips according to Section 403.03.08, as applicable.

The following sketch is primarily for the computation of quantities; however, the wedge will result in a similar cross-section where sufficient width exists. Do not construct a shoulder for placing the wedge unless specified elsewhere in the Contract.

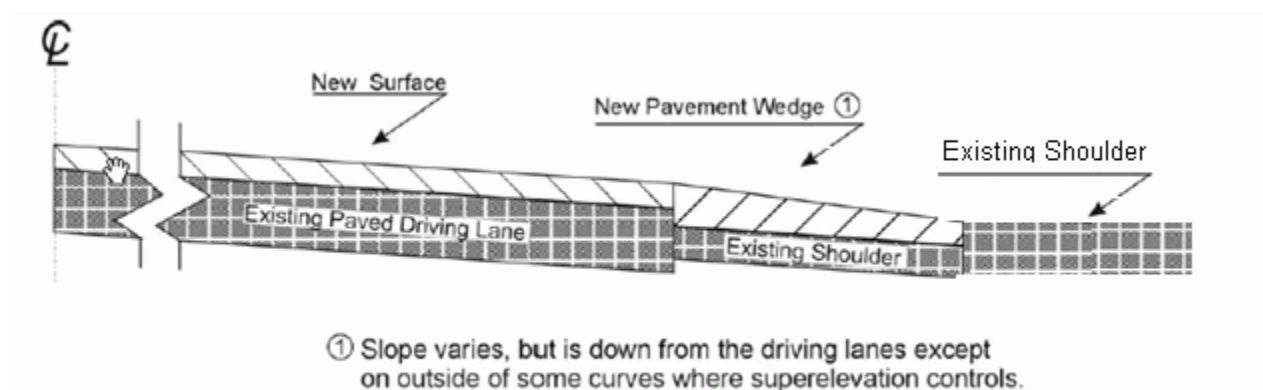

**3.0 MEASUREMENT.** The Department will measure Asphalt Surface Mixture placed as the pavement wedge according to Section 403.

**4.0 PAYMENT.** The Department will make payment for the completed and accepted quantities of Asphalt Surface Mixtures on pavement wedges according to Section 403.

### SPECIAL NOTE FOR EDGE KEY

Construct Edge Keys at the beginning of project, end of project, at railroad crossings, and at ramps, as applicable. Unless specified in the Contract or directed by the Engineer, do not construct edge keys at intersecting streets, roads, alleys, or entrances. Cut out the existing asphalt surface to the required depth and width shown on the drawing and heel the new surface into the existing surface. The Department will make payment for this work at the Contract unit price per ton for Asphalt Pavement Milling and Texturing, which shall be full compensation for all labor, materials, equipment, and incidentals for removal and disposal of the existing asphalt surface required to construct the edge key.

### EDGE KEY

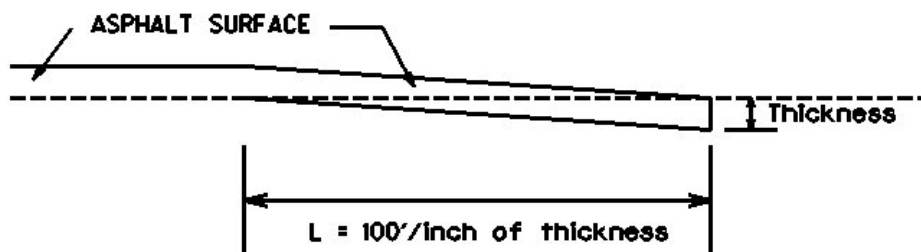

Thickness = **0.75** Inches

L = **75** LF

L= Length of Edge Key

1-3309 Edge key by Ton  
01/02//2012

**SPECIAL NOTE FOR  
ASPHALT MILLING AND TEXTURING**

Begin paving operations within **48 hours** of commencement of the milling operation. Continue paving operations continuously until completed. If paving operations are not begun within this time period, the Department will assess liquidated damages at the rate prescribed by Section 108.09 until such time as paving operations are begun.

Take possession of the millings and recycle the millings or dispose of the millings off the Right-of-Way at sites obtained by the Contractor at no additional cost to the Department.

1-3520 48 hours Contractor keeps millings  
01/2/2012

### **SPECIAL NOTE FOR TYPICAL SECTION DIMENSIONS**

Consider the dimensions shown on the typical sections for pavement and shoulder widths and thickness' to be nominal or typical dimensions. The Engineer may direct or approve varying the actual dimensions to be constructed to fit existing conditions. Do not widen existing pavement or shoulders unless specified elsewhere in this proposal or directed by the engineer.

1-3725 Typical Section Dimensions  
01/02/2012



## **TRAFFIC CONTROL PLAN**

---

### **TRAFFIC CONTROL GENERAL**

Except as provided herein, maintain and control traffic in accordance with the Standard and Supplemental Specifications and the Standard and Sepia Drawings, current editions. Except for the roadway and traffic control bid items listed, all items of work necessary to maintain and control traffic will be paid at the lump sum bid price to "Maintain and Control Traffic".

Contrary to Section 106.01, furnish new, or used in like new condition, traffic control devices at the beginning of the work and maintain in like new condition until completion of the work.

### **PROJECT PHASING & CONSTRUCTION PROCEDURES**

The Engineer may specify days and hours when lane closures will not be allowed.

Maintain alternating one way traffic during construction. Provide a minimum clear lane width of 10 feet; however, provide for passage of vehicles of up to 16 feet in width. If traffic should be stopped due to construction operations, and a school bus on an official run arrives on the scene, make provisions for the passage of the bus as quickly as possible.

### **LANE CLOSURES**

Do not leave lane closures in place during non-working hours.

### **SIGNS**

Sign posts and splices shall be compliant with NCHRP 350 or MASH. Manufacturer's documentation validating this compliance shall be provided to the Engineer prior to installation. Signs, including any splices, shall be installed according to manufacturer's specifications and installation recommendations. Contrary to section 112.04.02, only long-term signs (signs intended to be continuously in place for more than 3 days) will be measured for payment. Short-term signs (signs intended to be left in place for 3 days or less) will not be measured for payment but will be incidental to Maintain and Control Traffic.

### **CHANGEABLE MESSAGE SIGNS**

If deemed necessary by the Engineer, the Department will furnish, operate, and maintain Changeable Message Signs.

Traffic Control Plan  
Page 2 of 3

### **TEMPORARY ENTRANCES**

The Engineer will not require the Contractor to provide continuous access to farms, single family, duplex, or triplex residential properties during working hours; however, provide reasonable egress and ingress to each such property when actual operations are not in progress at that location. Limit the time during which a farm or residential entrance is blocked to the minimum length of time required for actual operations, not extended for the Contractor's convenience, and in no case exceeding six (6) hours. Notify all residents twenty-four hours in advance of any driveway or entrance closings and make any accommodations necessary to meet the access needs of disabled residents.

Except as allowed by the Phasing as specified above, maintain direct access to all side streets and roads, schools, churches, commercial properties and apartments or apartment complexes of four or more units at all times.

The Department will measure asphalt materials required to construct and maintain any temporary entrances which may be necessary to provide temporary access; however, the Department will not measure aggregates, excavation, and/or embankment, but shall be incidental to Maintain and Control Traffic. The Engineer will determine the type of surfacing material, asphalt or aggregate, to be used at each entrance.

### **THERMOPLASTIC INTERSECTION MARKINGS**

Consider the locations listed on the summary as approximate only. Prior to milling and/or resurfacing, locate and document the locations of the existing markings. After resurfacing, replace the markings at their approximate existing locations or as directed by Engineer. Place markings not existing prior to resurfacing as directed by the Engineer.

### **BARRICADES**

The Department will not measure barricades used in lieu of barrels and cones for channelization or delineation, but shall be incidental to Maintain and Control Traffic according to Section 112.04.01.

The Department will measure barricades used to protect pavement removal areas in individual units Each. The Department will measure for payment the maximum number of barricades in concurrent use at the same time on a single day on all sections of the contract. The Department will measure individual barricades only once for payment, regardless of how many times they are set, reset, removed, and relocated during the duration of the project. The Department will not measure replacements for damaged barricades the Engineer directs to be replaced due to poor condition or reflectivity. Retain possession of the Barricades upon completion of construction.

Traffic Control Plan  
Page 3 of 3

## **PAVEMENT MARKINGS**

If there is to be a deviation from the existing striping plan, the Engineer will furnish the Contractor a striping plan prior to placement of the final surface course.

Install Temporary Striping according to Section 112 with the following exception:

If the Contractor's operations or phasing requires temporary markings that must subsequently be removed from the final surface course, use an approved removable lane tape; however, the Department will not measure removable lane tape for separate payment, but will measure and pay for removable lane tape as temporary striping.

## **PAVEMENT EDGE DROP-OFFS**

Do not allow a pavement edge between opposing directions of traffic or lanes that traffic is expected to cross in a lane change situation with an elevation difference greater than 1½". Place Warning signs (MUTCD W8-11 or W8-9A) in advance of and at 1500' intervals throughout the drop-off area. Dual post the signs on both sides of the traveled way. Wedge all transverse transitions between resurfaced and unresurfaced areas which traffic may cross with asphalt mixture for leveling and wedging. Remove the wedges prior to placement of the final surface course.

Protect pavement edges that traffic is not expected to cross, except accidentally, as follows:

Less than 2" - No protection required.

2" to 4" - Place plastic drums, vertical panels, or barricades every 50 feet. During daylight working hours only, the Engineer will allow the Contractor to use cones in lieu of plastic drums, panels, and barricades. Wedge the drop-off with DGA or asphalt mixture for leveling and wedging with a 1:1 or flatter slope in daylight hours, or 3:1 or flatter slope during nighttime hours, when work is not active in the drop-off area.

Greater than 4" - Protect drop-offs greater than 4 inches within 10 feet of traffic by placing drums, vertical panels, or barricades every 25 feet. The Engineer will not allow the use of cones in lieu of drums, vertical panels, or barricades for drop-offs greater than 4". Place Type III Barricades directly in front of the drop-off facing on coming traffic in both directions of travel. Provide warning signs as shown on the Standard Drawings or as directed by the Engineer

Pedestrians & Bicycles - Protect pedestrian and bicycle traffic as directed by the engineer.

DURABLE PAVEMENT EDGE DETAIL

(Resurfacing adjacent to fill slope or ditch foreslope that is 3:1 or less)

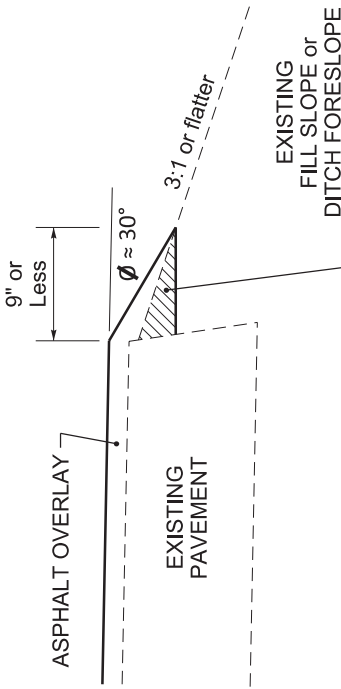

PREPARE SHOULDER ACCORDING TO STANDARD SPECIFICATIONS

DURABLE PAVEMENT EDGE DETAIL

(Resurfacing adjacent to fill slope or ditch foreslope that is steeper than 3:1)

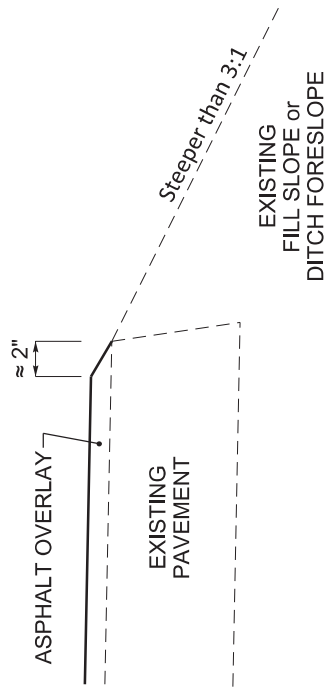

DURABLE PAVEMENT EDGE DETAIL

(Resurfacing adjacent to low shoulder with dropoff of 5 inches or less)

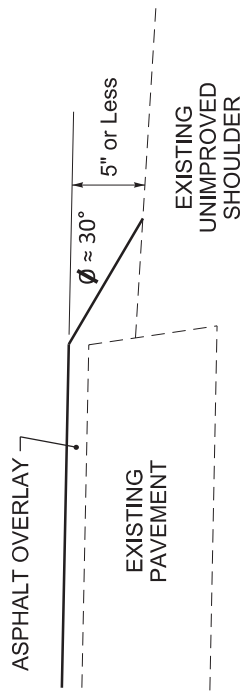

DURABLE PAVEMENT EDGE DETAIL

(Resurfacing adjacent to low shoulder with dropoff of more than 5 inches)

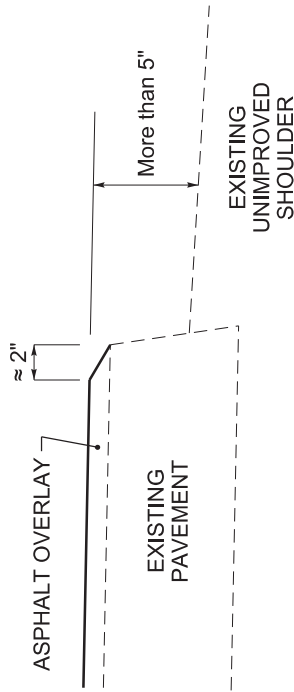

DURABLE PAVEMENT EDGE DETAIL

(Resurfacing adjacent to an obstruction, such as an existing headwall)

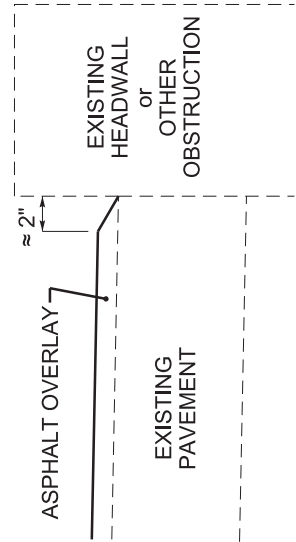

NOTES

1. DETAILS DO NOT APPLY TO OVERLAYS LESS THAN 1 INCH THICK.
2. THE DURABLE PAVEMENT EDGE DEVICE MAY BE DISENGAGED AT DRIVEWAYS, SIDE STREETS, HIGH SHOULDERS, AND OTHER LOCATIONS NOT FEASIBLE TO CONSTRUCT, AS APPROVED BY THE ENGINEER.

DRAWING NOT TO SCALE

DURABLE PAVEMENT EDGE DETAILS

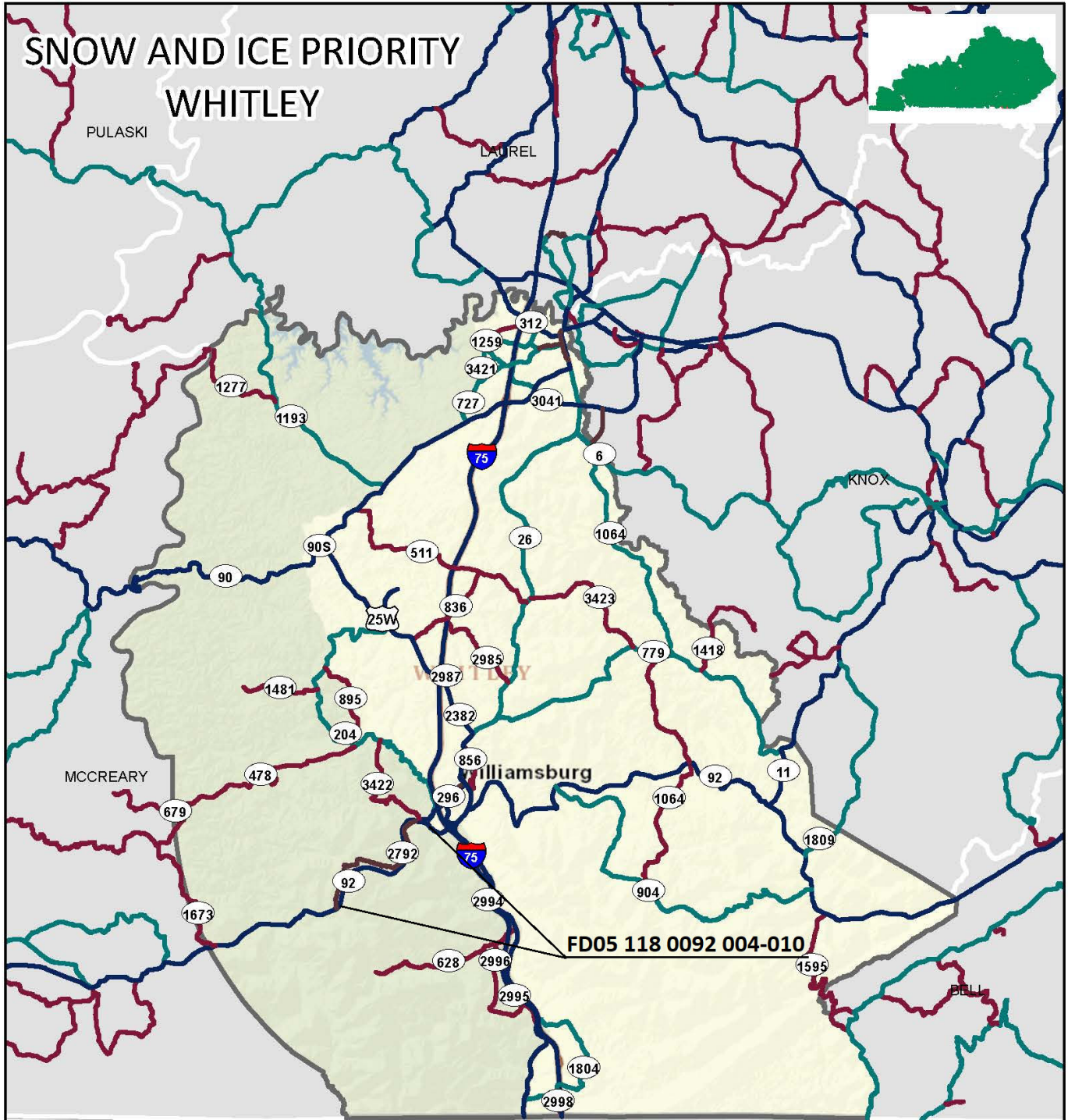

- Priority**
- A
  - B
  - C
  - D
  - UNASSIGNED

Produced by KYTC Maintenance Branch  
Contact: Chris.Lambert@ky.gov  
Date: 1/6/2017

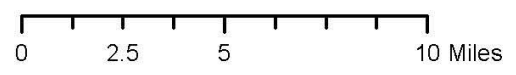

Source KYTC





**WHITLEY COUNTY**  
**FD05 118 0092 004-010**  
**TYPICAL SECTION**  
**MILEPOINTS 4.000 - 4.110**  
**MICROSURFACING ALTERNATE**

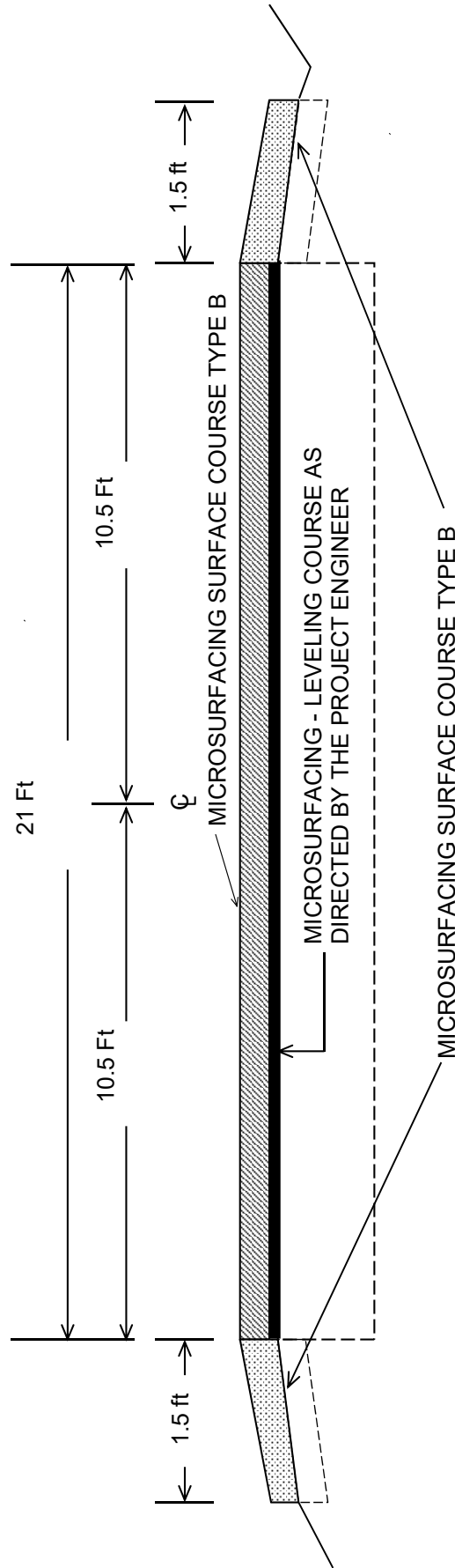

**\*Where Existing Site Conditions Permit**



**WHITLEY COUNTY**  
**FD05 118 0092 004-010**  
**TYPICAL SECTION 3 LANE**  
**MILEPOINTS 4.110 - 5.520, 6.080 - 7.720**  
**MICROSURFACING ALTERNATE**

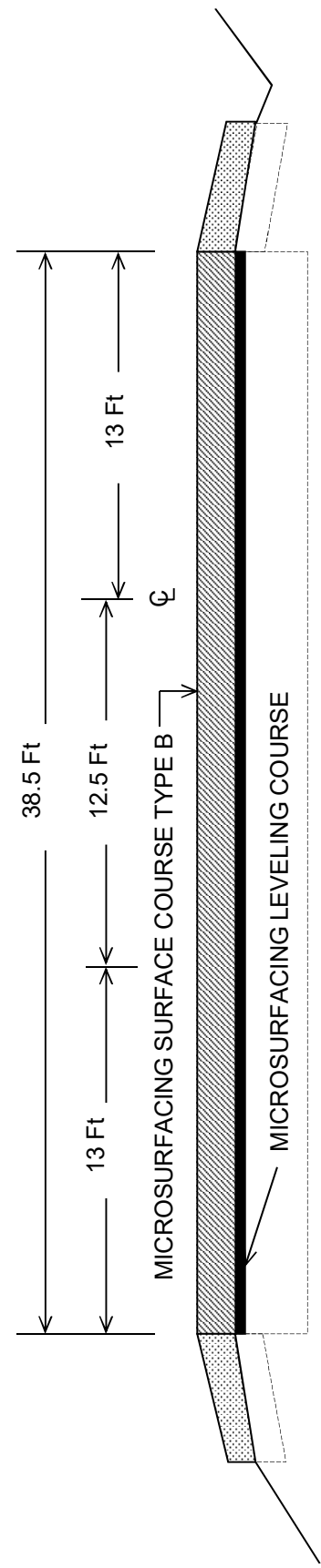

WHITLEY COUNTY  
FD05 118 0092 004-010  
TYPICAL SECTION 4 LANE  
MILEPOINTS 5.520 - 6.080

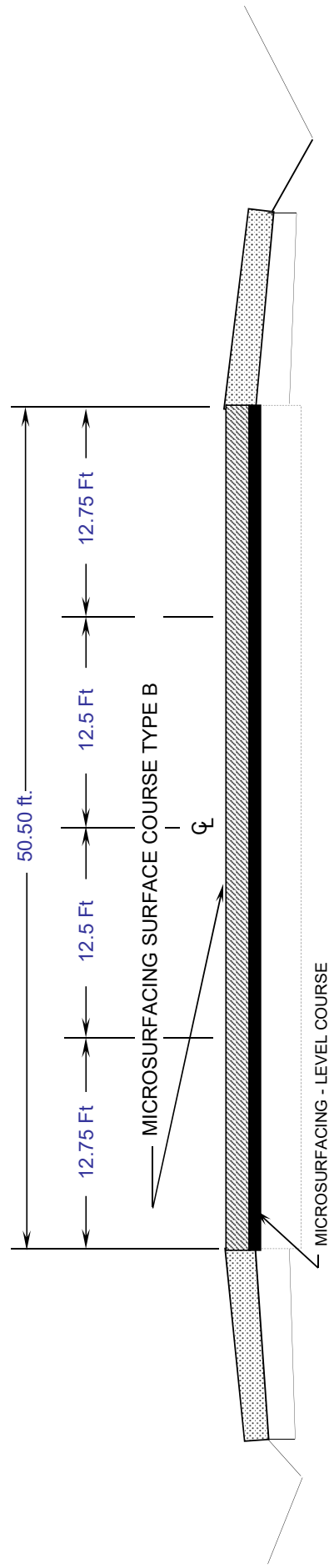

**WHITLEY COUNTY**  
**FD05 118 0092 00-010**  
**TYPICAL SECTION**  
**MILEPOINTS 7.720 - 9.550**  
**MICROSURFACING ALTERNATE**

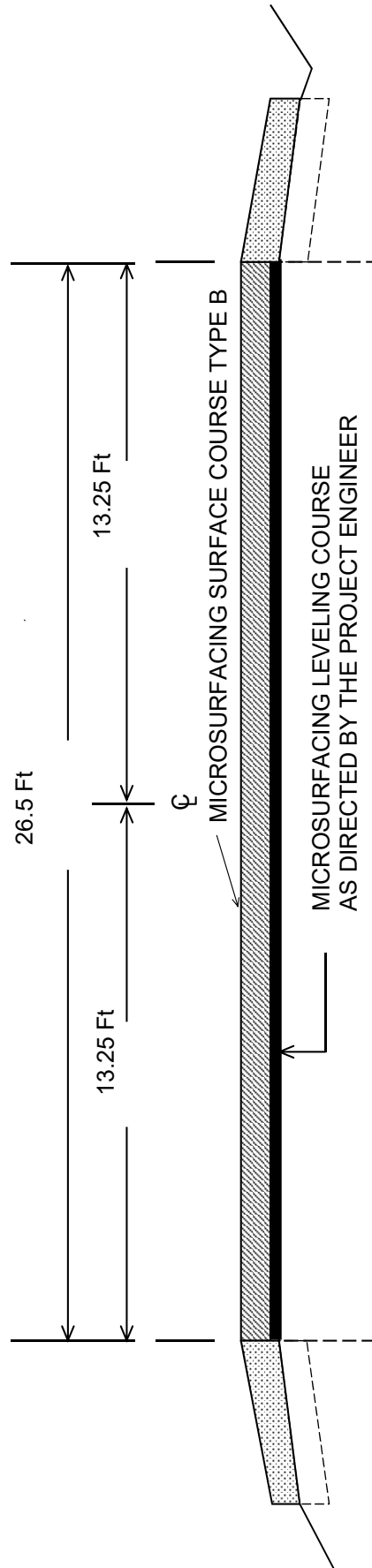

**WHITLEY COUNTY**  
**FD05 118 0092 004-010**  
**TYPICAL SECTION**  
**MILEPOINTS 4.000 - 4.110**  
**ULTRA THIN ALTERNATE**

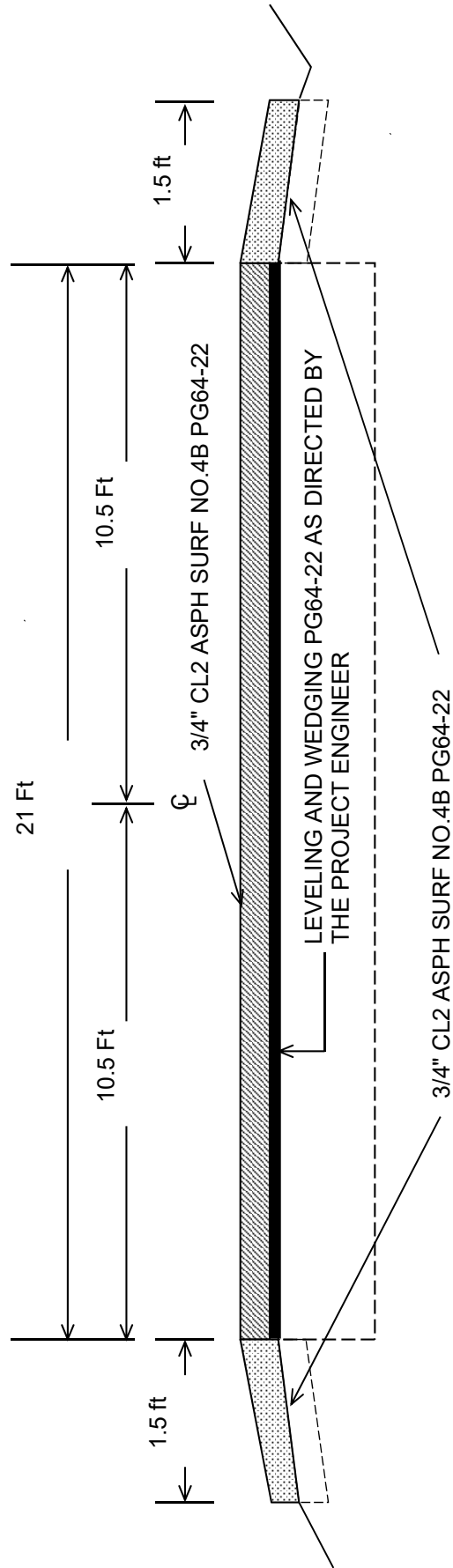

**\*Where Existing Site Conditions Permit**

**WHITLEY COUNTY**  
**FD05 118 0092 004-010**  
**TYPICAL SECTION 3 LANE**  
**MILEPOINTS 4.110 - 5.520, 6.080 - 7.720**  
**ULTRA THIN ALTERNATE**

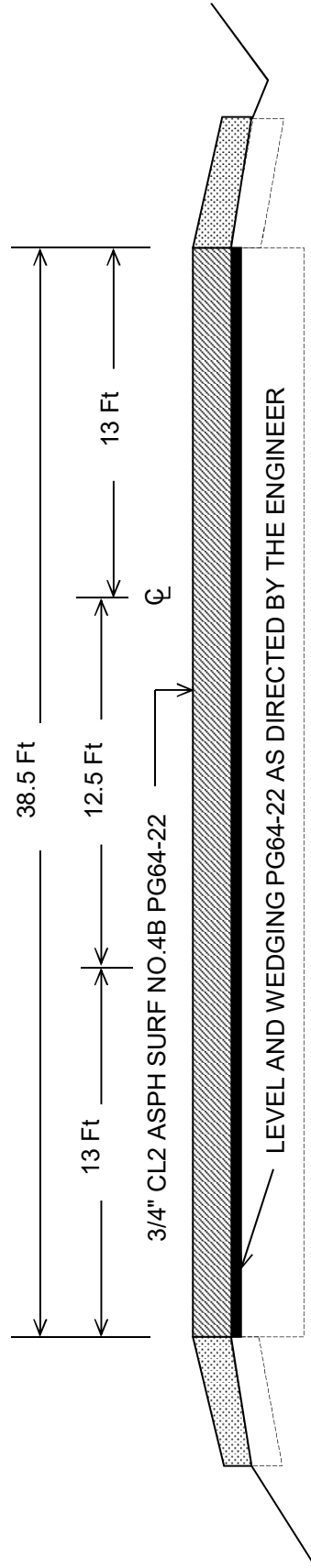

WHITLEY COUNTY  
FD05 118 0092 004-010  
TYPICAL SECTION 4 LANE  
MILEPOINTS 5.520 - 6.080

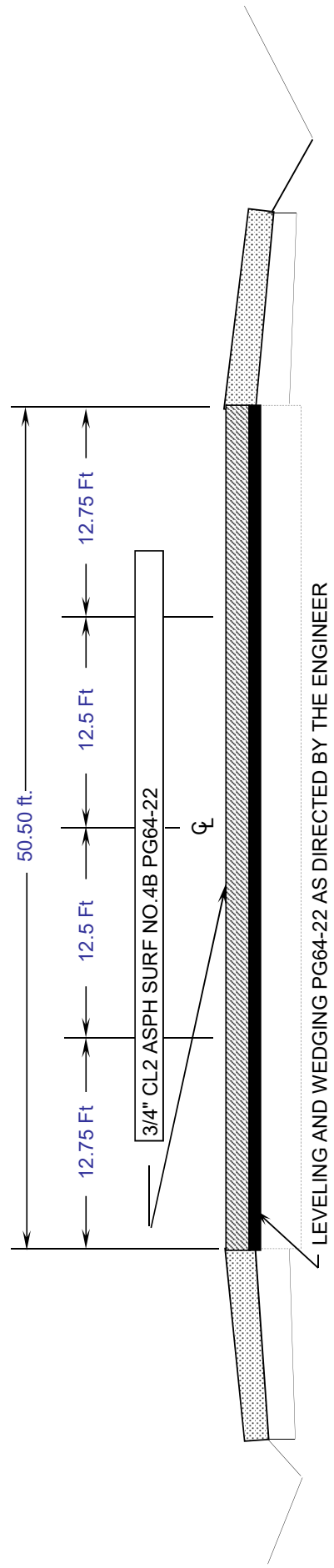

**WHITLEY COUNTY**

**FD05 118 0092 00-010  
TYPICAL SECTION  
MILEPOINTS 7.720 - 9.550  
ULTRA THIN ALTERNATE**

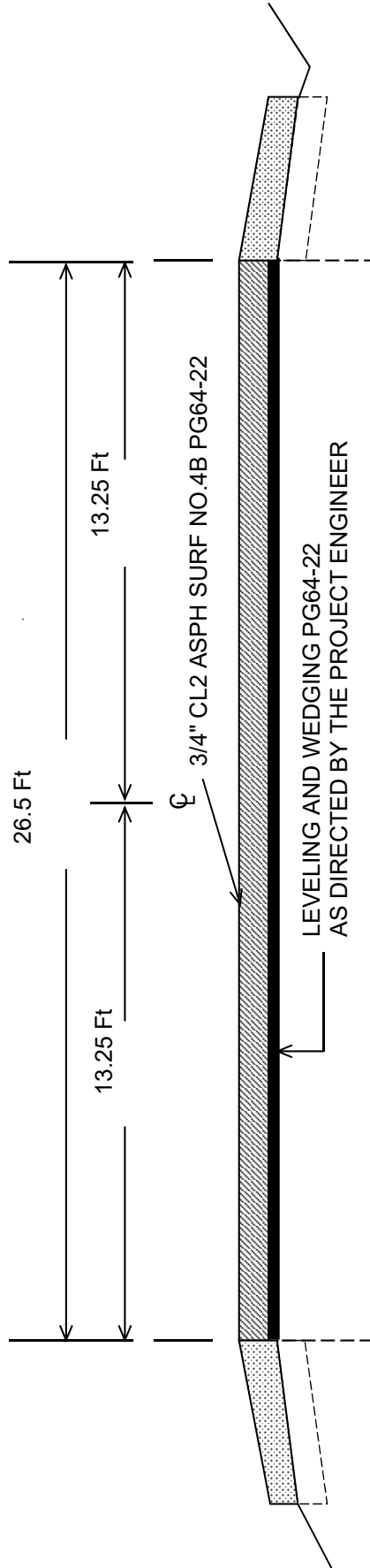

**PART II**  
**SPECIFICATIONS AND STANDARD DRAWINGS**



### **SPECIFICATIONS REFERENCE**

Any reference in the plans or proposal to previous editions of the *Standard Specifications for Road and Bridge Construction* and *Standard Drawings* are superseded by *Standard Specifications for Road and Bridge Construction, Edition of 2012* and *Standard Drawings, Edition of 2016*.

## **SUPPLEMENTAL SPECIFICATIONS**

The contractor shall use the Supplemental Specifications that are effective at the time of letting.  
The Supplemental Specifications can be found at the following link:

<http://transportation.ky.gov/Construction/Pages/Kentucky-Standard-Specifications.aspx>

## 2016 KENTUCKY STANDARD DRAWINGS

CURVE WIDENING AND SUPERELEVATION TRANSITIONS .....	RGS-001-07
SUPERELEVATION FOR MULTILANE PAVEMENT .....	RGS-002-06
MISCELLANEOUS STANDARDS .....	RGX-001-06
APPROACHES, ENTRANCES, AND MAIL BOX TURNOUT .....	RPM-110-07
LANE CLOSURE TWO-LANE HIGHWAY .....	TTC-100-04
SHOULDER CLOSURE .....	TTC-135-02
PAVEMENT CONDITION WARNING SIGNS .....	TTD-125-02
MOBILE OPERATION FOR PAINT STRIPING CASE I .....	TTS-100-02
MOBILE OPERATION FOR PAINT STRIPING CASE II .....	TTS-105-02

**PART III**

**EMPLOYMENT, WAGE AND RECORD REQUIREMENTS**

**TRANSPORTATION CABINET  
DEPARTMENT OF HIGHWAYS**

**LABOR AND WAGE REQUIREMENTS  
APPLICABLE TO OTHER THAN FEDERAL-AID SYSTEM PROJECTS**

- I. Application
- II. Nondiscrimination of Employees (KRS 344)

**I. APPLICATION**

1. These contract provisions shall apply to all work performed on the contract by the contractor with his own organization and with the assistance of workmen under his immediate superintendence and to all work performed on the contract by piecework, station work or by subcontract. The contractor's organization shall be construed to include only workmen employed and paid directly by the contractor and equipment owned or rented by him, with or without operators.

2. The contractor shall insert in each of his subcontracts all of the stipulations contained in these Required Provisions and such other stipulations as may be required.

3. A breach of any of the stipulations contained in these Required Provisions may be grounds for termination of the contract.

3. If the contractor is in control of apprenticeship or other training or retraining, including on-the-job training programs, he shall not discriminate against an individual because of his race, color, religion, national origin, sex, disability or age forty (40) and over, in admission to, or employment in any program established to provide apprenticeship or other training.

4. The contractor will send to each labor union or representative of workers with which he has a collective bargaining agreement or other contract or understanding, a notice to be provided advising the said labor union or workers' representative of the contractor's commitments under this section, and shall post copies of the notice in conspicuous places available to employees and applicants for employment. The contractor will take such action with respect to any subcontract or purchase order as the administrating agency may direct as a means of enforcing such provisions, including sanctions for non-compliance.

Revised: January 25, 2017

**II. NONDISCRIMINATION OF EMPLOYEES**

**AN ACT OF THE KENTUCKY  
GENERAL ASSEMBLY TO PREVENT  
DISCRIMINATION IN EMPLOYMENT  
KRS CHAPTER 344  
EFFECTIVE JUNE 16, 1972**

The contract on this project, in accordance with KRS Chapter 344, provides that during the performance of this contract, the contractor agrees as follows:

1. The contractor shall not fail or refuse to hire, or shall not discharge any individual, or otherwise discriminate against an individual with respect to his compensation, terms, conditions, or privileges of employment, because of such individual's race, color, religion, national origin, sex, disability or age (forty and above); or limit, segregate, or classify his employees in any way which would deprive or tend to deprive an individual of employment opportunities or otherwise adversely affect his status as an employee, because of such individual's race, color, religion, national origin, sex, disability or age forty (40) and over. The contractor agrees to post in conspicuous places, available to employees and applicants for employment, notices to be provided setting forth the provisions of this nondiscrimination clause.

2. The contractor shall not print or publish or cause to be printed or published a notice or advertisement relating to employment by such an employer or membership in or any classification or referral for employment by the employment agency, indicating any preference, limitation, specification, or discrimination, based on race, color, religion, national origin, sex, or age forty (40) and over, or because the person is a qualified individual with a disability, except that such a notice or advertisement may indicate a preference, limitation, or specification based on religion, national origin, sex, or age forty (40) and over, or because the person is a qualified individual with a disability, when religion, national origin, sex, or age forty (40) and over, or because the person is a qualified individual with a disability, is a bona fide occupational qualification for employment.

## EXECUTIVE BRANCH CODE OF ETHICS

In the 1992 regular legislative session, the General Assembly passed and Governor Brereton Jones signed Senate Bill 63 (codified as KRS 11A), the Executive Branch Code of Ethics, which states, in part:

KRS 11A.040 (7) provides:

No present or former public servant shall, within six (6) months following termination of his office or employment, accept employment, compensation, or other economic benefit from any person or business that contracts or does business with, or is regulated by, the state in matters in which he was directly involved during the last thirty-six (36) months of his tenure. This provision shall not prohibit an individual from returning to the same business, firm, occupation, or profession in which he was involved prior to taking office or beginning his term of employment, or for which he received, prior to his state employment, a professional degree or license, provided that, for a period of six (6) months, he personally refrains from working on any matter in which he was directly involved during the last thirty-six (36) months of his tenure in state government. This subsection shall not prohibit the performance of ministerial functions, including but not limited to filing tax returns, filing applications for permits or licenses, or filing incorporation papers, nor shall it prohibit the former officer or public servant from receiving public funds disbursed through entitlement programs.

KRS 11A.040 (9) states:

A former public servant shall not represent a person or business before a state agency in a matter in which the former public servant was directly involved during the last thirty-six (36) months of his tenure, for a period of one (1) year after the latter of:

- a) The date of leaving office or termination of employment; or
- b) The date the term of office expires to which the public servant was elected.

This law is intended to promote public confidence in the integrity of state government and to declare as public policy the idea that state employees should view their work as a public trust and not as a way to obtain private benefits.

If you have worked for the executive branch of state government within the past six months, you may be subject to the law's prohibitions. The law's applicability may be different if you hold elected office or are contemplating representation of another before a state agency.

Also, if you are affiliated with a firm which does business with the state and which employs former state executive-branch employees, you should be aware that the law may apply to them.

In case of doubt, the law permits you to request an advisory opinion from the Executive Branch Ethics Commission, 3 Fountain Place, Frankfort, Kentucky 40601; telephone (502) 564-7954.

Revised: January 27, 2017

### **Kentucky Equal Employment Opportunity Act of 1978**

The requirements of the Kentucky Equal Employment Opportunity Act of 1978 (KRS 45.560-45.640) shall apply to this Contract. The apparent low Bidder will be required to submit EEO forms to the Division of Construction Procurement, which will then forward to the Finance and Administration Cabinet for review and approval. No award will become effective until all forms are submitted and EEO/CC has certified compliance. The required EEO forms are as follows:

- EEO-1: Employer Information Report
- Affidavit of Intent to Comply
- Employee Data Sheet
- Subcontractor Report

These forms are available on the Finance and Administration's web page under ***Vendor Information, Standard Attachments and General Terms*** at the following address:  
**<https://www.eProcurement.ky.gov>**.

Bidders currently certified as being in compliance by the Finance and Administration Cabinet may submit a copy of their approval letter in lieu of the referenced EEO forms.

For questions or assistance please contact the Finance and Administration Cabinet by email at **[finance.contractcompliance@ky.gov](mailto:finance.contractcompliance@ky.gov)** or by phone at 502-564-2874.

# EMPLOYEE RIGHTS UNDER THE FAIR LABOR STANDARDS ACT

THE UNITED STATES DEPARTMENT OF LABOR WAGE AND HOUR DIVISION

## FEDERAL MINIMUM WAGE

# \$7.25 PER HOUR

BEGINNING JULY 24, 2009

**OVERTIME PAY** At least 1½ times your regular rate of pay for all hours worked over 40 in a workweek.

**CHILD LABOR** An employee must be at least **16** years old to work in most non-farm jobs and at least **18** to work in non-farm jobs declared hazardous by the Secretary of Labor.

Youths **14** and **15** years old may work outside school hours in various non-manufacturing, non-mining, non-hazardous jobs under the following conditions:

**No more than**

- **3** hours on a school day or **18** hours in a school week;
- **8** hours on a non-school day or **40** hours in a non-school week.

Also, work may not begin before **7 a.m.** or end after **7 p.m.**, except from June 1 through Labor Day, when evening hours are extended to **9 p.m.** Different rules apply in agricultural employment.

**TIP CREDIT** Employers of “tipped employees” must pay a cash wage of at least \$2.13 per hour if they claim a tip credit against their minimum wage obligation. If an employee’s tips combined with the employer’s cash wage of at least \$2.13 per hour do not equal the minimum hourly wage, the employer must make up the difference. Certain other conditions must also be met.

**ENFORCEMENT** The Department of Labor may recover back wages either administratively or through court action, for the employees that have been underpaid in violation of the law. Violations may result in civil or criminal action.

Employers may be assessed civil money penalties of up to \$1,100 for each willful or repeated violation of the minimum wage or overtime pay provisions of the law and up to \$11,000 for each employee who is the subject of a violation of the Act’s child labor provisions. In addition, a civil money penalty of up to \$50,000 may be assessed for each child labor violation that causes the death or serious injury of any minor employee, and such assessments may be doubled, up to \$100,000, when the violations are determined to be willful or repeated. The law also prohibits discriminating against or discharging workers who file a complaint or participate in any proceeding under the Act.

### ADDITIONAL INFORMATION

- Certain occupations and establishments are exempt from the minimum wage and/or overtime pay provisions.
- Special provisions apply to workers in American Samoa and the Commonwealth of the Northern Mariana Islands.
- Some state laws provide greater employee protections; employers must comply with both.
- The law requires employers to display this poster where employees can readily see it.
- Employees under 20 years of age may be paid \$4.25 per hour during their first 90 consecutive calendar days of employment with an employer.
- Certain full-time students, student learners, apprentices, and workers with disabilities may be paid less than the minimum wage under special certificates issued by the Department of Labor.

For additional information:



# 1-866-4-USWAGE

(1-866-487-9243)

TTY: 1-877-889-5627



# WWW.WAGEHOUR.DOL.GOV



**PART IV**  
**INSURANCE**

## INSURANCE

The Contractor shall procure and maintain the following insurance in addition to the insurance required by law:

- 1) Commercial General Liability-Occurrence form – not less than \$2,000,000 General aggregate, \$2,000,000 Products & Completed Aggregate, \$1,000,000 Personal & Advertising, \$1,000,000 each occurrence.
- 2) Automobile Liability- \$1,000,000 per accident
- 3) Employers Liability:
  - a) \$100,000 Each Accident Bodily Injury
  - b) \$500,000 Policy limit Bodily Injury by Disease
  - c) \$100,000 Each Employee Bodily Injury by Disease
- 4) The insurance required above must be evidenced by a Certificate of Insurance and this Certificate of Insurance must contain one of the following statements:
  - a) "policy contains no deductible clauses."
  - b) "policy contains \_\_\_\_\_ (amount) deductible property damage clause but company will pay claim and collect the deductible from the insured."
- 5) KENTUCKY WORKMEN'S COMPENSATION INSURANCE. The contractor shall furnish evidence of coverage of all his employees or give evidence of self-insurance by submitting a copy of a certificate issued by the Workmen's Compensation Board.

The cost of insurance is incidental to all contract items. All subcontractors must meet the same minimum insurance requirements.

**PART V**  
**BID ITEMS**

**PROPOSAL BID ITEMS**

182402

Page 1 of 1

Report Date 12/5/18

**Section: 0001 - MICROSURFACE**

LINE	BID CODE	ALT	DESCRIPTION	QUANTITY	UNIT	UNIT PRIC	FP	AMOUNT
0010	21652EN		MICROSURFACING-LEVELING COURSE	115,479.00	SQYD		\$	
0020	24957EC		MICROSURFACING-SURFACE COURSE - TYPE B (REVISED: 12-5-18)	115,479.00	SQYD		\$	

**Section: 0002 - THINLAY**

LINE	BID CODE	ALT	DESCRIPTION	QUANTITY	UNIT	UNIT PRIC	FP	AMOUNT
0030	00190		LEVELING & WEDGING PG64-22	335.00	TON		\$	
0040	00356		ASPHALT MATERIAL FOR TACK	52.00	TON		\$	
0050	02676		MOBILIZATION FOR MILL & TEXT	1.00	LS		\$	
0060	02677		ASPHALT PAVE MILLING & TEXTURING	10.00	TON		\$	
0070	24888EC		CL2 ASPH SURF NO.4B PG64-22 (REVISED: 12-5-18)	4,850.00	TON		\$	

**Section: 0003 - ROADWAY**

LINE	BID CODE	ALT	DESCRIPTION	QUANTITY	UNIT	UNIT PRIC	FP	AMOUNT
0080	02562		TEMPORARY SIGNS	300.00	SQFT		\$	
0090	02650		MAINTAIN & CONTROL TRAFFIC	1.00	LS		\$	
0100	06510		PAVE STRIPING-TEMP PAINT-4 IN	62,500.00	LF		\$	
0110	06514		PAVE STRIPING-PERM PAINT-4 IN	125,000.00	LF		\$	
0120	06568		PAVE MARKING-THERMO STOP BAR-24IN	120.00	LF		\$	
0130	06600		REMOVE PAVEMENT MARKER TYPE V	500.00	EACH		\$	
0135	23071EN		OVERBAND CRACK SEALING (ADDED: 12-3-18)	23,898.00	LB		\$	

**Section: 0004 - DEMOBILIZATION**

LINE	BID CODE	ALT	DESCRIPTION	QUANTITY	UNIT	UNIT PRIC	FP	AMOUNT
0140	02569		DEMOBILIZATION	1.00	LS		\$	